

ANBEFALINGER TIL MONTERING OG VEDLIGEHOLDELSE

Montering i team: På grund af målene 4x6 m og antallet af komponenter (f.eks. 34 skruer M6*50 og 62 elastiske stropper) anbefaler vi, at monteringen udføres af mindst 2 til 3 voksne personer.

Kontrol af samlinger: Kontroller under monteringen og jævnligt under brug, at alle skruesamlinger (L, O, R) er stramme, og at beslagene (D, E, H, J) er stabile.















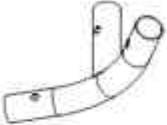



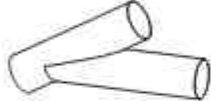

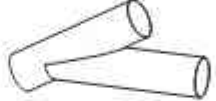
Opbevaring: Sørg for, at alle presenninger (T, U, V) og metaldele (A, B, C) er helt tørre og rene inden opbevaring. Opbevaring i fugtig tilstand kan medføre skimmel på presenningerne eller korrosion af materialet.

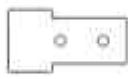
JURIDISK ANSVARFRASKRIVELSE

Ansvarsbegrænsning: Hverken producenten eller sælgeren er ansvarlig for skader på ejendom, personskade eller tab forårsaget af forkert montering, manglende vedligeholdelse eller manglende overholdelse af sikkerhedsinstruktionerne i denne vejledning.

Force majeure: Garantien dækker ikke skader forårsaget af force majeure (ekstremt vejr, oversvømmelser, storme). Under sådanne forhold er brugeren forpligtet til at sikre eller demontere teltet i tide.

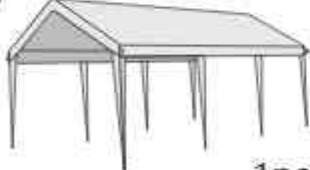
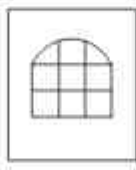
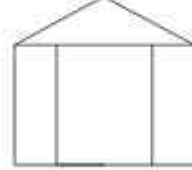
Anvendelsesformål: Brug af teltet til andre formål end de tiltænkte (f.eks. som lager, garage til køretøjer eller permanent læ) sker på brugerens eget ansvar og medfører tab af reklamationsretten.

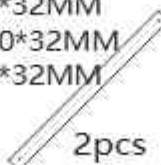
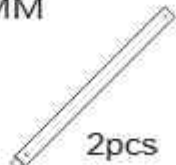
<p>A 1873*38MM</p>  <p>8pcs</p>	<p>A1 (4x6M) 250*38MM (5x6M) 760*38MM (6x6M) 1270*38MM</p>  <p>8pcs</p>	<p>B 1873*38MM</p>  <p>9pcs</p>	<p>C 1920*38MM</p>  <p>8pcs</p>
<p>D</p>  <p>6pcs</p>	<p>E</p>  <p>6pcs</p>	<p>F (4x6M) 1066*38MM (5x6M) 1066*38MM (6x6M) 1920*38MM</p>  <p>4pcs</p>	<p>G 1920*32MM</p>  <p>12pcs</p>
<p>H</p>  <p>8pcs</p>	<p>I 880*38MM</p>  <p>4pcs</p>	<p>J</p>  <p>8pcs</p>	<p>K</p>  <p>8pcs</p>
<p>L</p>  <p>12pcs</p>	<p>M</p>  <p>16pcs</p>	<p>N</p>  <p>16pcs</p>	<p>O</p>  <p>M6*50 34pcs</p>
<p>P</p>  <p>28pcs</p>	<p>Q</p>  <p>4pcs</p>	<p>R</p>  <p>24pcs</p>	<p>S</p>  <p>2pcs</p>
<p>T</p>  <p>1pcs</p>	<p>U</p>  <p>6pcs</p>	<p>V</p>  <p>2pcs</p>	<p>W</p>  <p>62pcs</p>
<p>X 1920*32MM</p>  <p>4pcs</p>	<p>Y 330*32MM (4x6M) 330*32MM (5x6M) 1330*32MM (6x6M) 330*32MM</p>  <p>2pcs</p>	<p>Y1 (6x6M) 1920*32MM</p>  <p>2pcs</p>	

STEP 1



(A) X2



(A1) X2



(D) X1

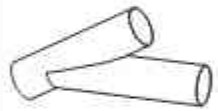

(H) X2



(F) X2

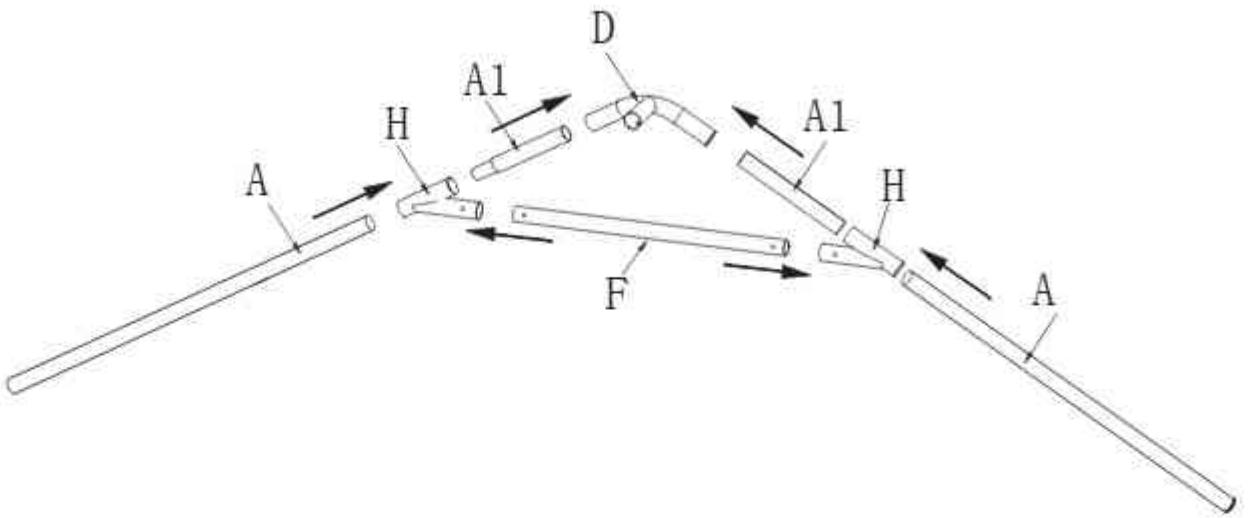

STEP 2



(D) X2

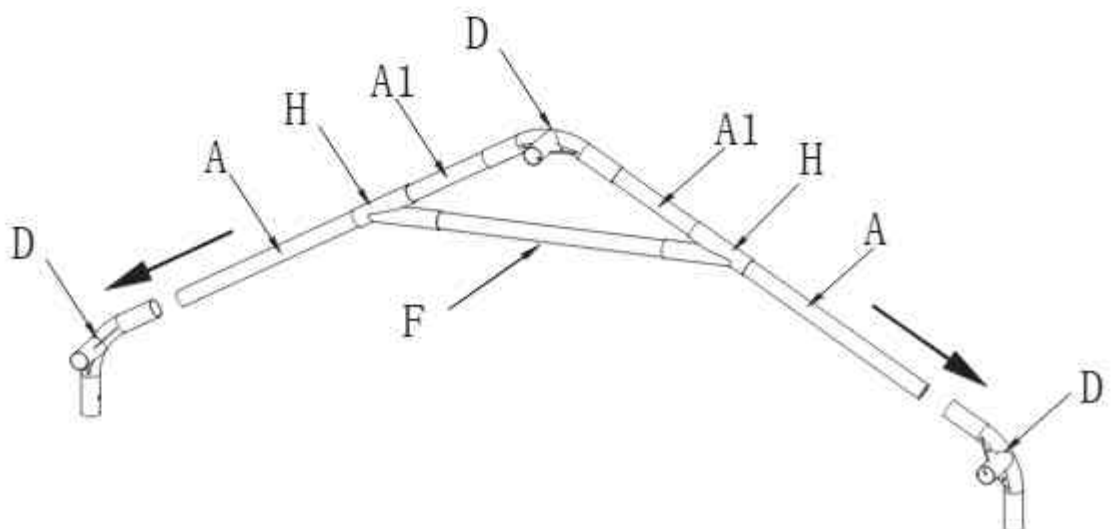

STEP 3

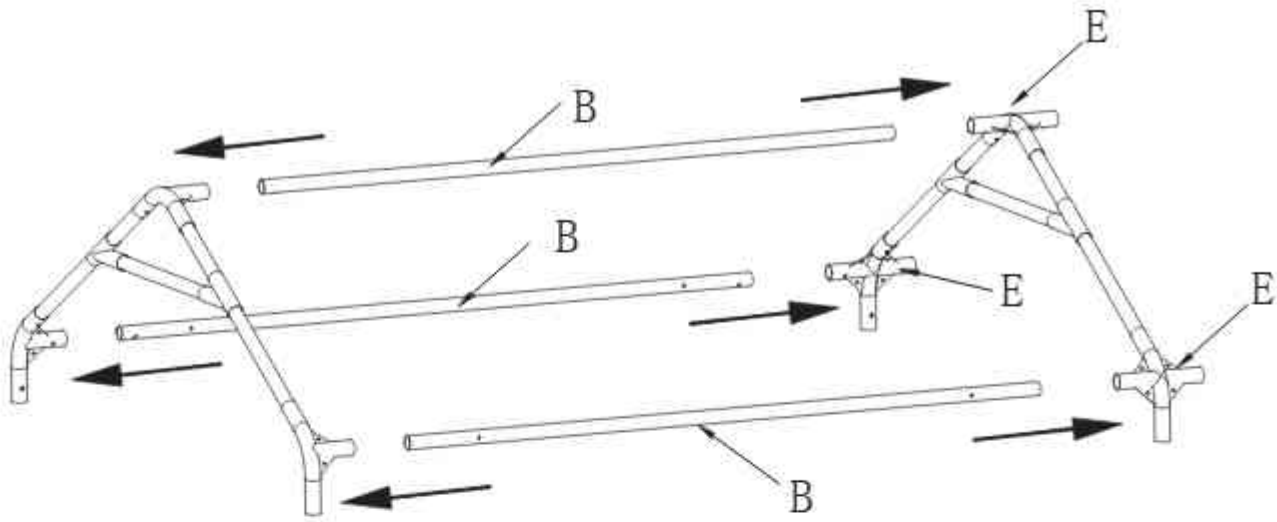

(B) X3



(E) X3

STEP 4

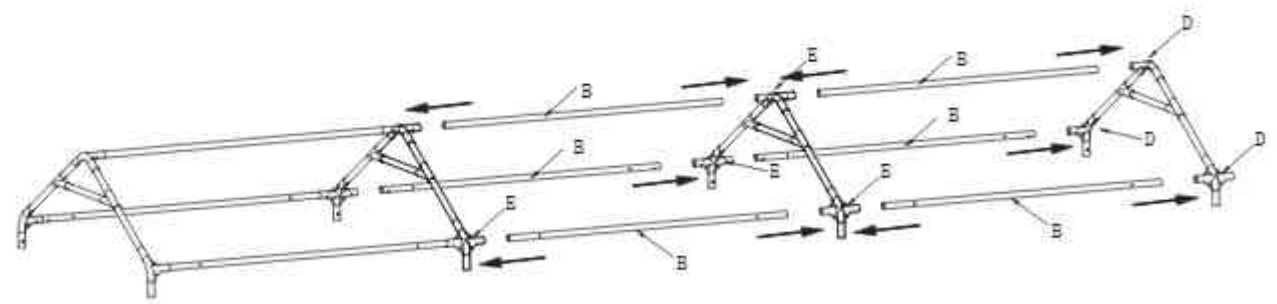

X1

X1

(B) X6

STEP 5

(G) X6

(I) X16

(M) X8

(N) X8

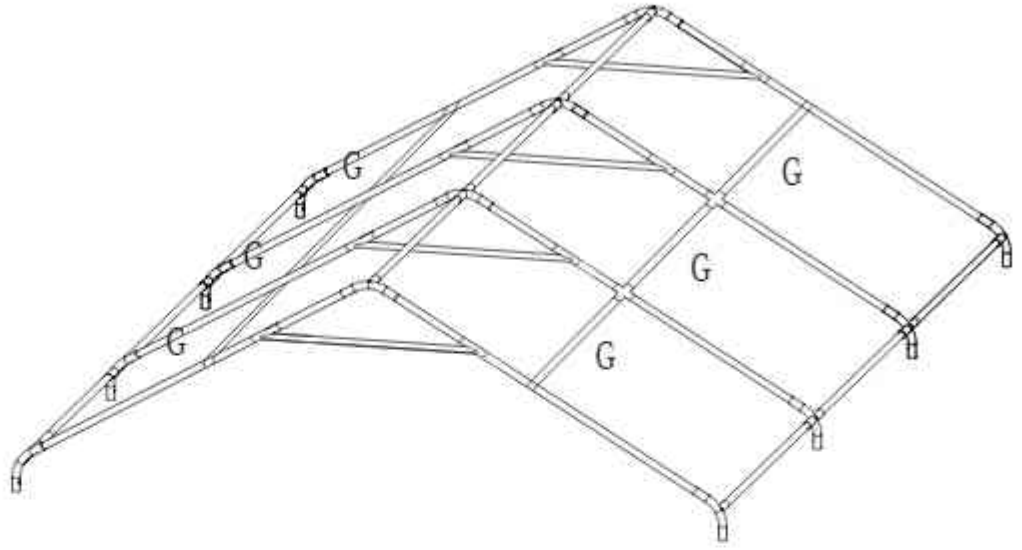

STEP 6

(T) X1

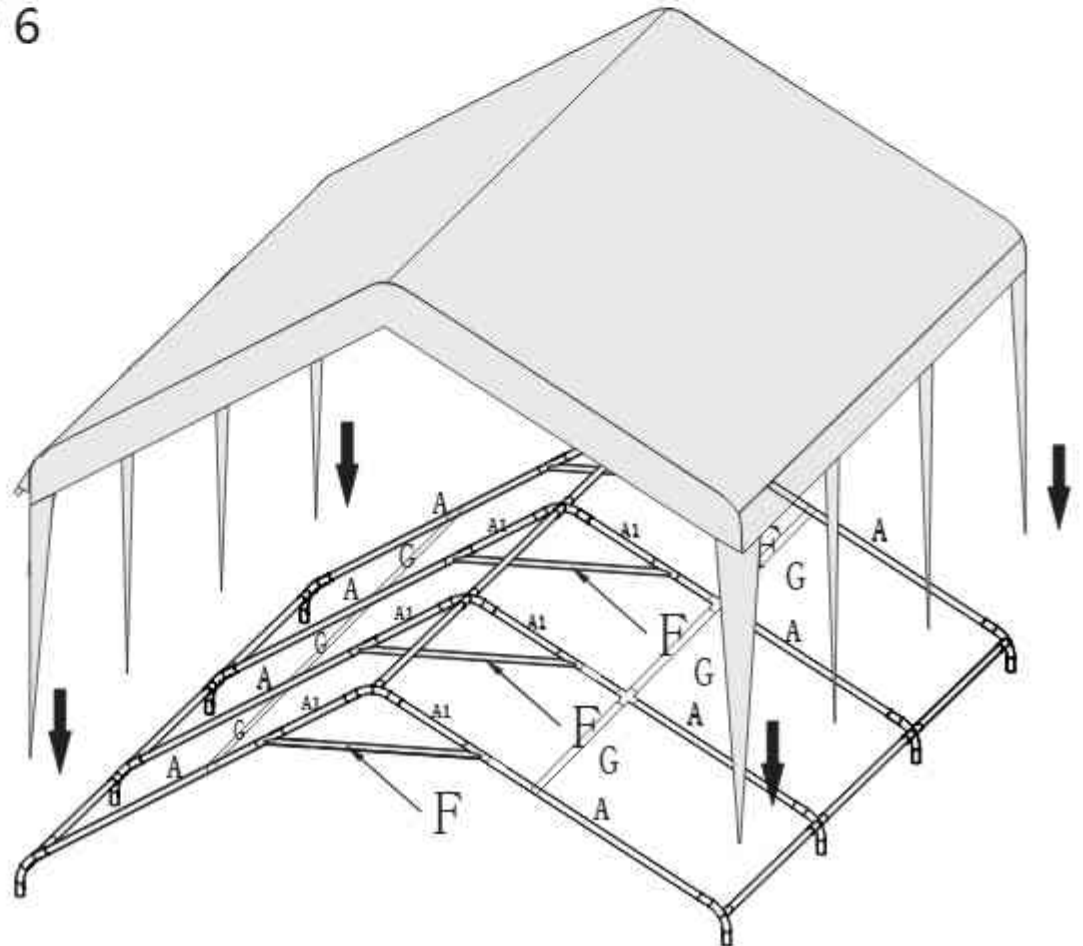

STEP 7



(C) X1



(L) X1



(K) X1

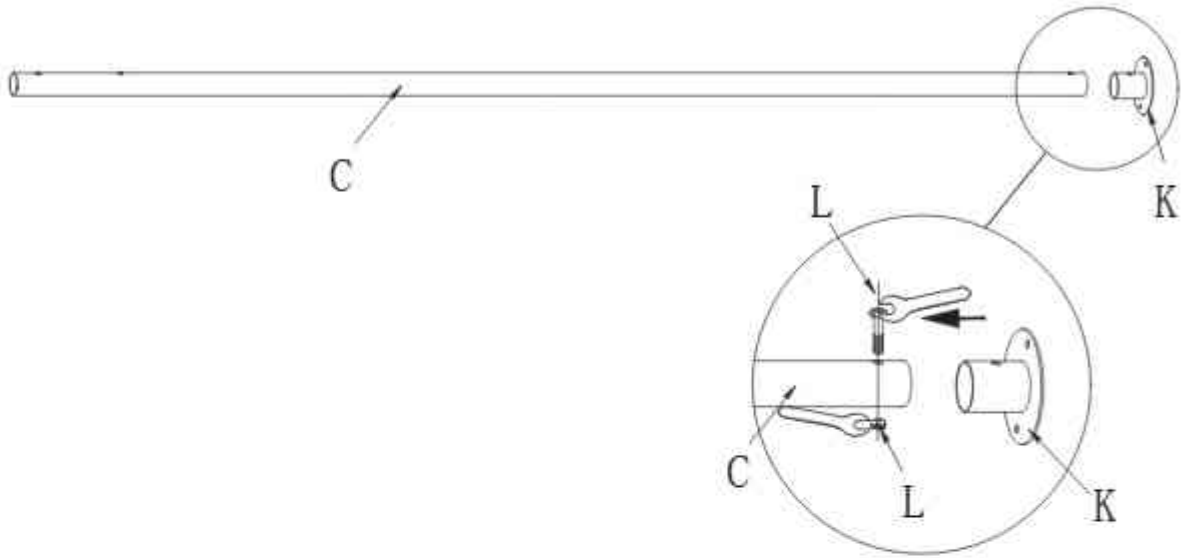

STEP 8



(C) X8



(J) X8



(I) X4

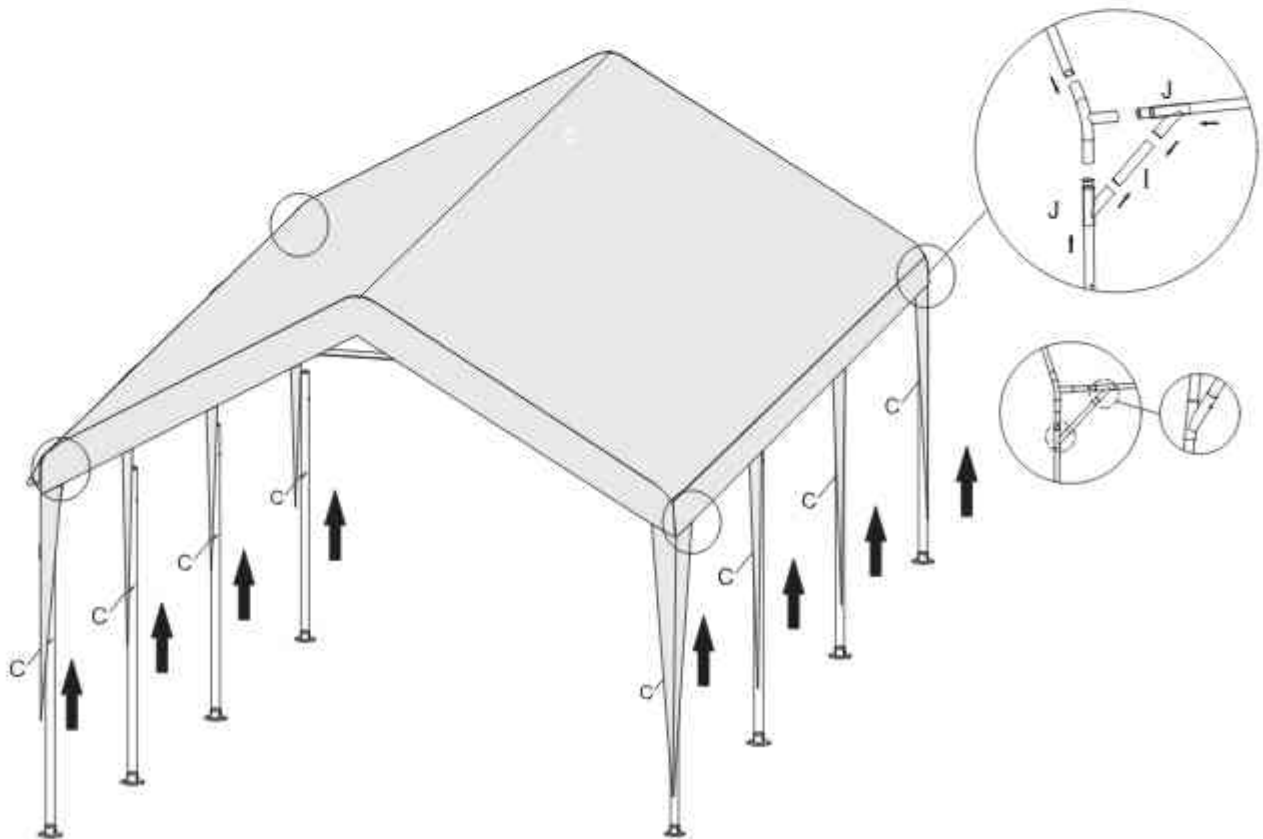



STEP 9

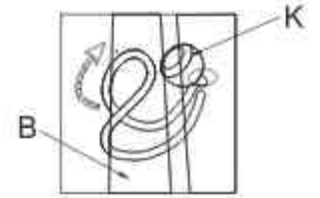

U X6

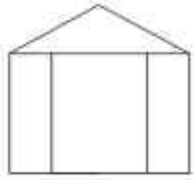
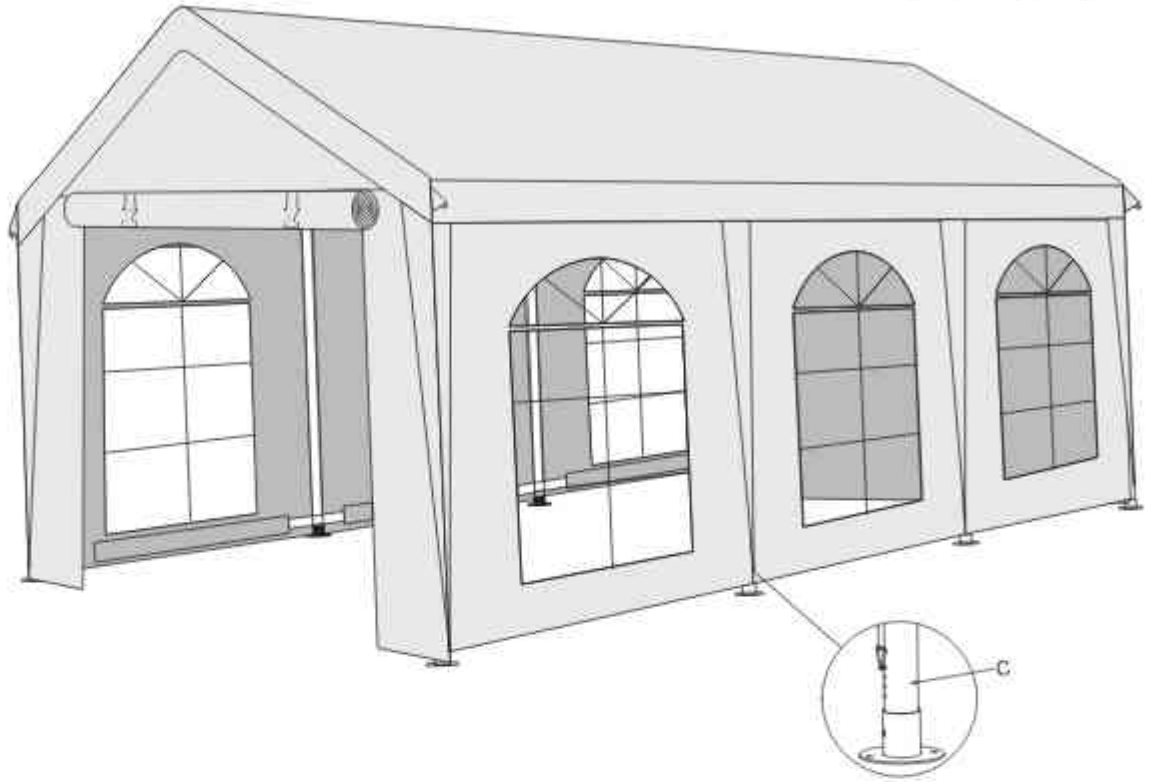

V X2



W X62

STEP 10



X X2

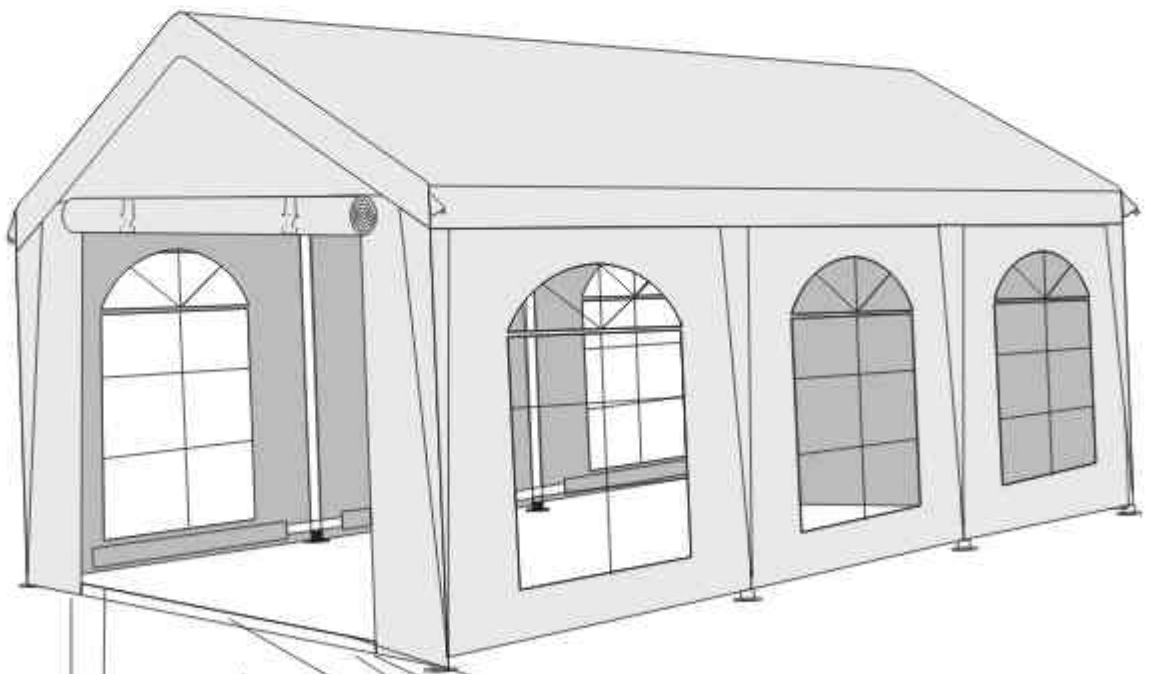

Y X1



Y1 X1 (6x6M)

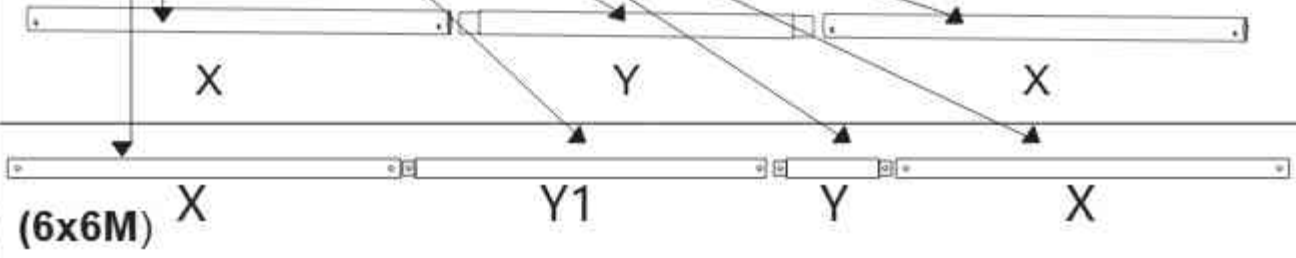

STEP 11



G X6



M6*50

O X16



M X8



N X8

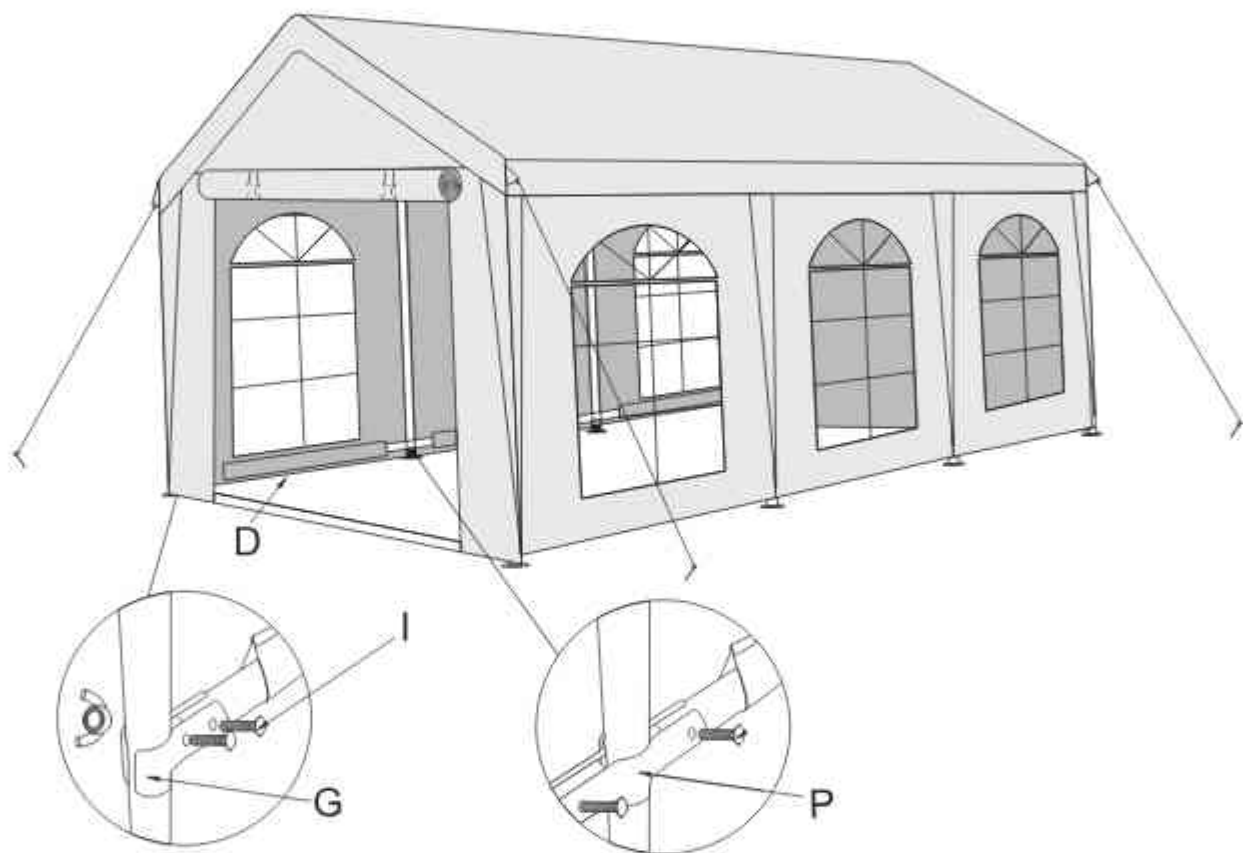

SIKKERHEDSADVARSEL Kortvarig brug:

Dette partytelt er udelukkende designet som midlertidigt ly til kortvarige sociale begivenheder. Det er ikke beregnet til permanent brug eller som en langsigtet overdækningsløsning. Obligatorisk forankring: Teltet skal under alle omstændigheder være korrekt forankret til jorden ved hjælp af de medfølgende pløkker (P), snore (Q) og fødder (K). Efterlad aldrig et fritstående telt uden opsyn. Vejrforhold: I tilfælde af udsigt til dårligt vejr, såsom kraftig vind, storm, hagl eller kraftigt snefald, skal teltet straks tages ned. Konstruktionen er ikke dimensioneret til at modstå ekstrem vind- eller snebelastning. Brandsikkerhed: Brug ikke åben ild, grill, varmeapparater eller andre varmekilder inde i teltet eller i umiddelbar nærhed heraf. Der er risiko for beskadigelse af dugen (T, U, V) eller brand. Ophobning af vand og sne: Kontroller tagdugen (T) regelmæssigt for at forhindre ophobning af regnvand eller sne. Overdreven vægt kan forårsage deformation af metalstængerne (A, B, C) eller få konstruktionen til at kollapse.

DETALJERET MONTERINGSPROCEDURE (TEKNISK LOGIK)

Ved montering skal du følge de nummererede trin i billedvejledningen: Forberedelse af tagrammen (Trin 1 – 4): Saml først den øverste del af konstruktionen (spæret). Brug midterbeslagene (D, H) og stængerne (A, A1, F). Tilføj gradvist de langsgående stænger (B) ved hjælp af beslagene (E). Forstærkning af taget (Trin 5): Monter tagforstærkningerne (G). Disse stænger er afgørende for dugens stabilitet og vandafløb. Påsætning af tagdug (Trin 6): Træk tagdugen (T) over konstruktionen, før teltet løftes op på benene. Det er sikrere og nemmere. Løft på benene (Trin 7 – 8): Sæt gradvist benstængerne (C) ind i beslagene. Sæt en fod (K) på den nederste del af hvert ben. Montering af vægge og bundramme (Trin 9 – 10): Fastgør sidevæggene med vinduer (U) og indgangsdelen (V) ved hjælp af de elastiske stropper (W). Forbind til sidst bundstængerne (X, Y) for maksimal stivhed i konstruktionen. Endelig sikring (Trin 11): Kontroller, at alle skruer (O, R) er strammet, og at teltet er forsvarligt forankret med pløkker (P) i jorden.

YDERLIGERE ANBEFALINGER TIL BRUGEREN

Vindretning: Hvis du sætter teltet op i let vind, skal indgangen vende mod vinden for at undgå "faldskærmseffekten".





Beskyttelse af tekstilet: Brug ikke overdreven kraft, når du strammer de elastiske stropper (W), for at undgå at rive øjerne ud af dugen.

Garanti mod korrosion: Selvom stængerne er lakerede, anbefaler vi at behandle stedet med rustbeskyttelsesspray ved ridser under monteringen, da det er en stålkonstruktion.

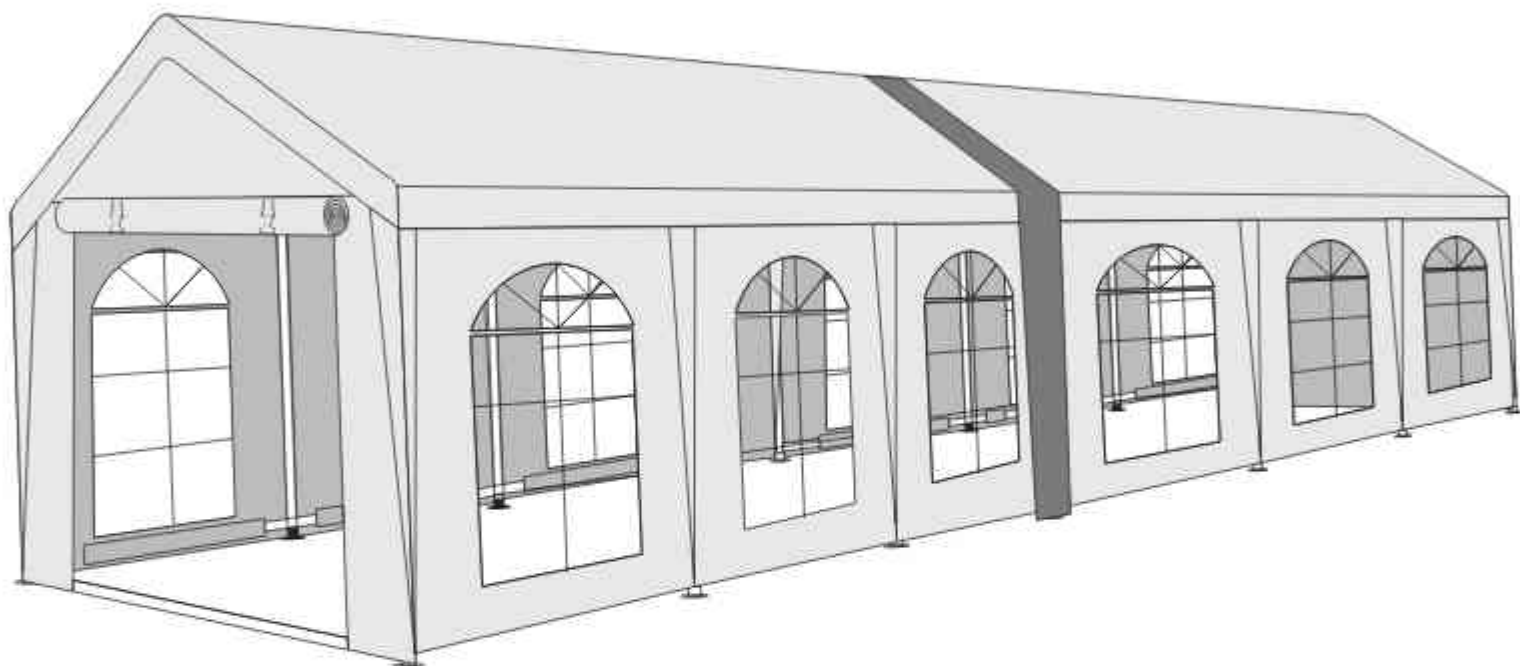
SAMMENKOBLING AF TO TELTE - til længde 12m og mere (FORLÆNGELSE)

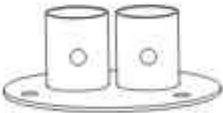
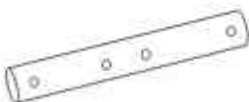
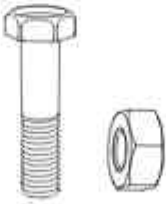
 Ved køb af et telt med en længde på 12 m eller mere er dette tilbehør automatisk inkluderet i prisen. For telte 4x6 m, 5x6 m, 6x6 m er dette tilbehør mod et tillæg.



A  2PCS	B  2PCS	C  4PCS	D  1PCS
E  2PCS	F  4PCS	G S 4PCS	

STEP 1

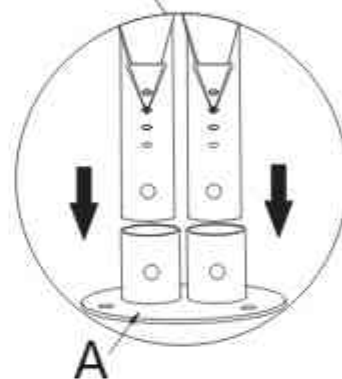
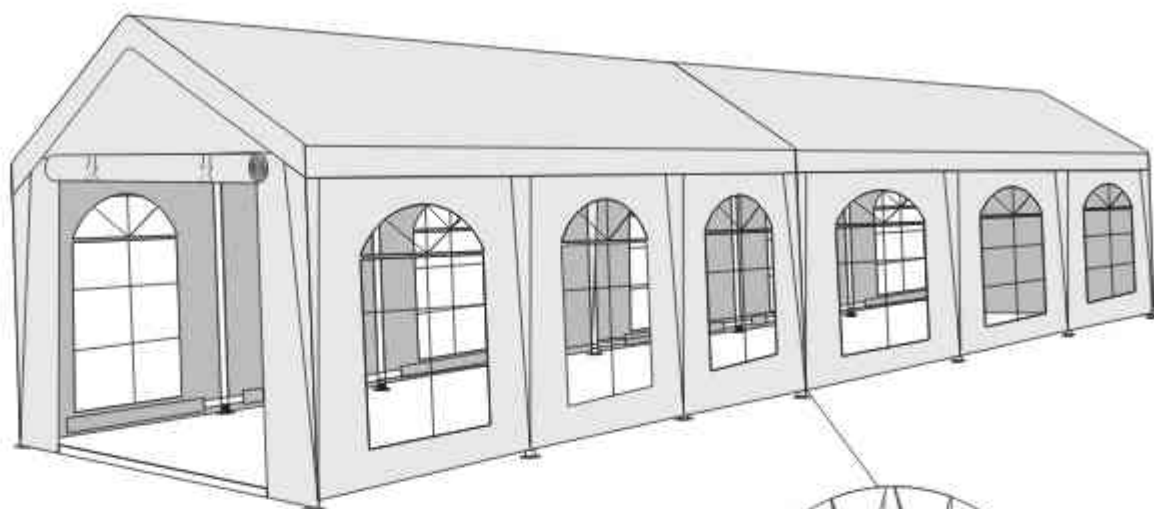
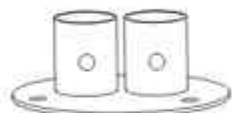

(A) X2

STEP 2

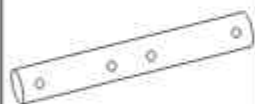

(B) X2



(C) X4



(E) X2

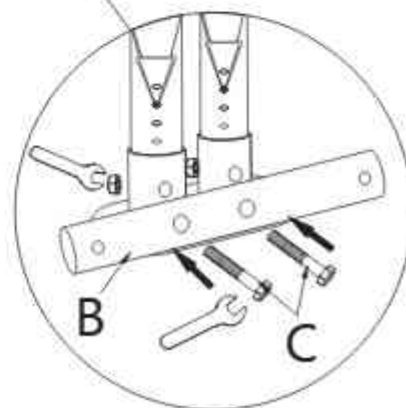
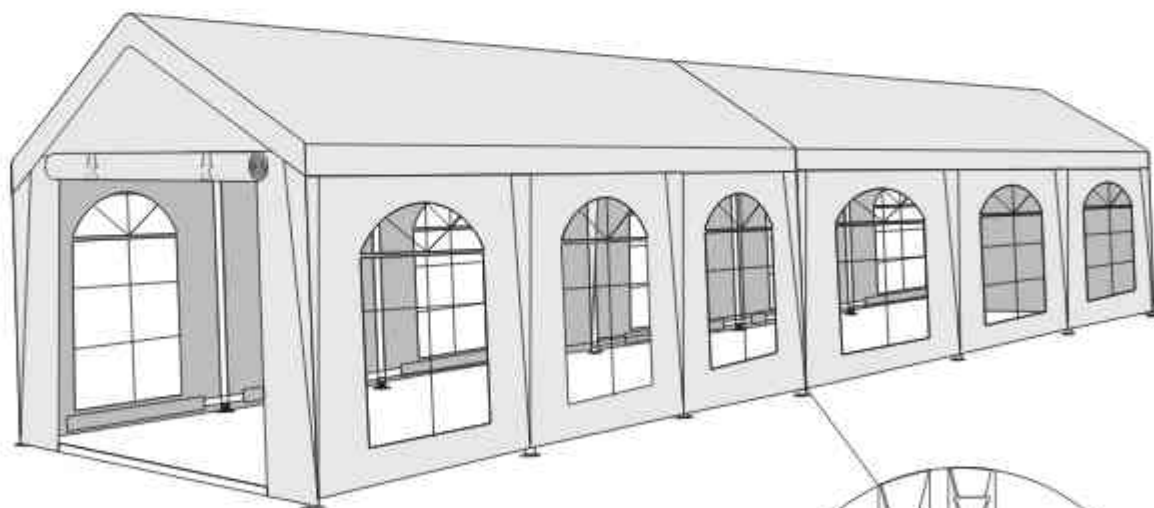

STEP 3

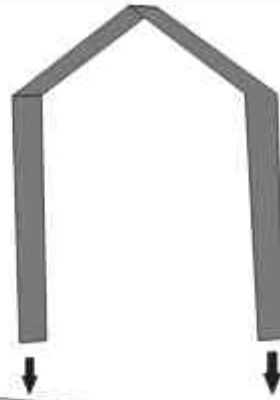

Ⓓ X1

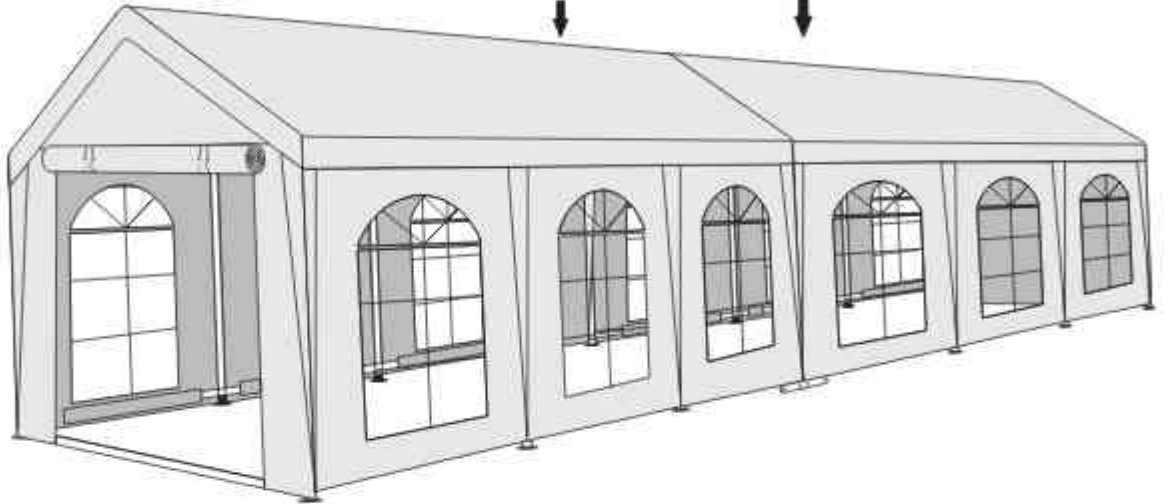

STEP 4



Ⓕ X4

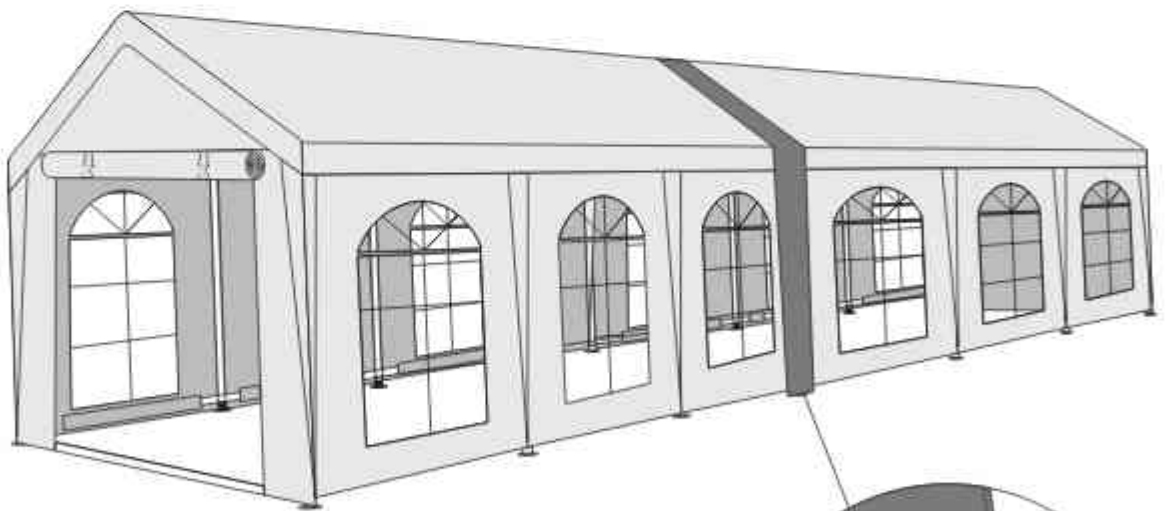

S

Ⓖ X4

